

S-AIRBAG INTELLIGENT VEST S30 USER GUIDE

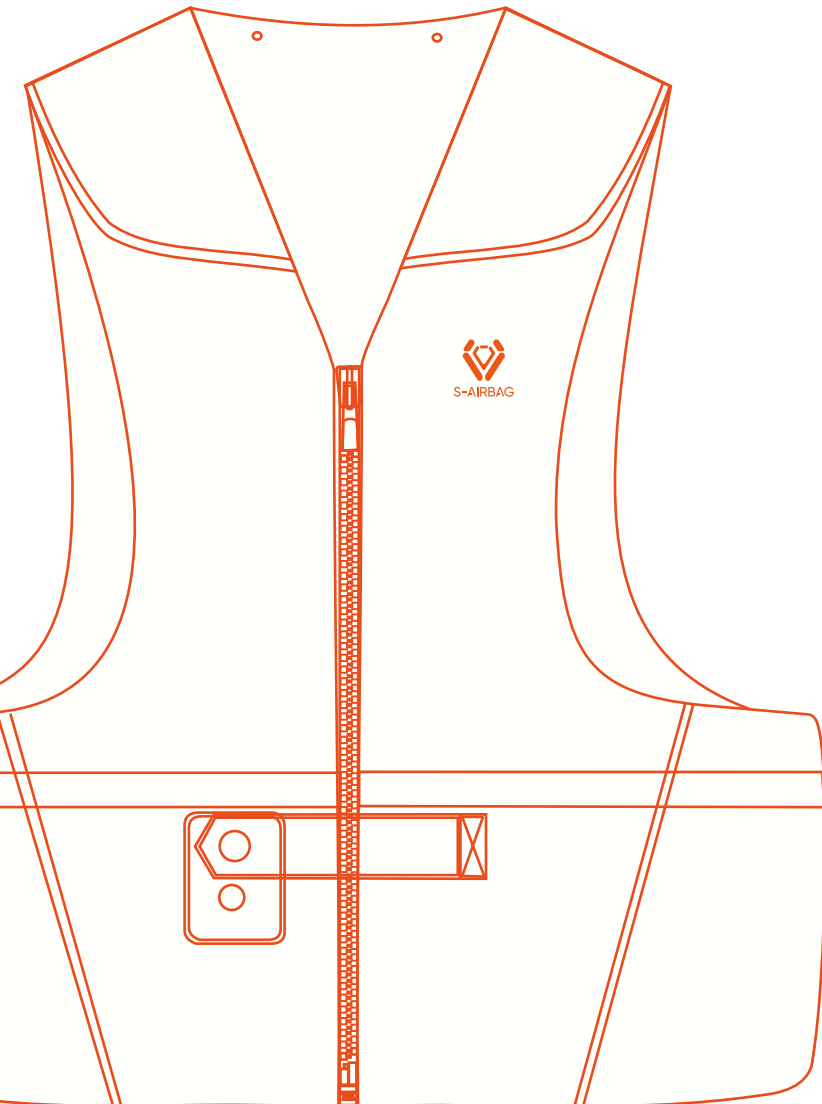

S-AIRBAG
PROACTIVE BODY PROTECTION EXPERT

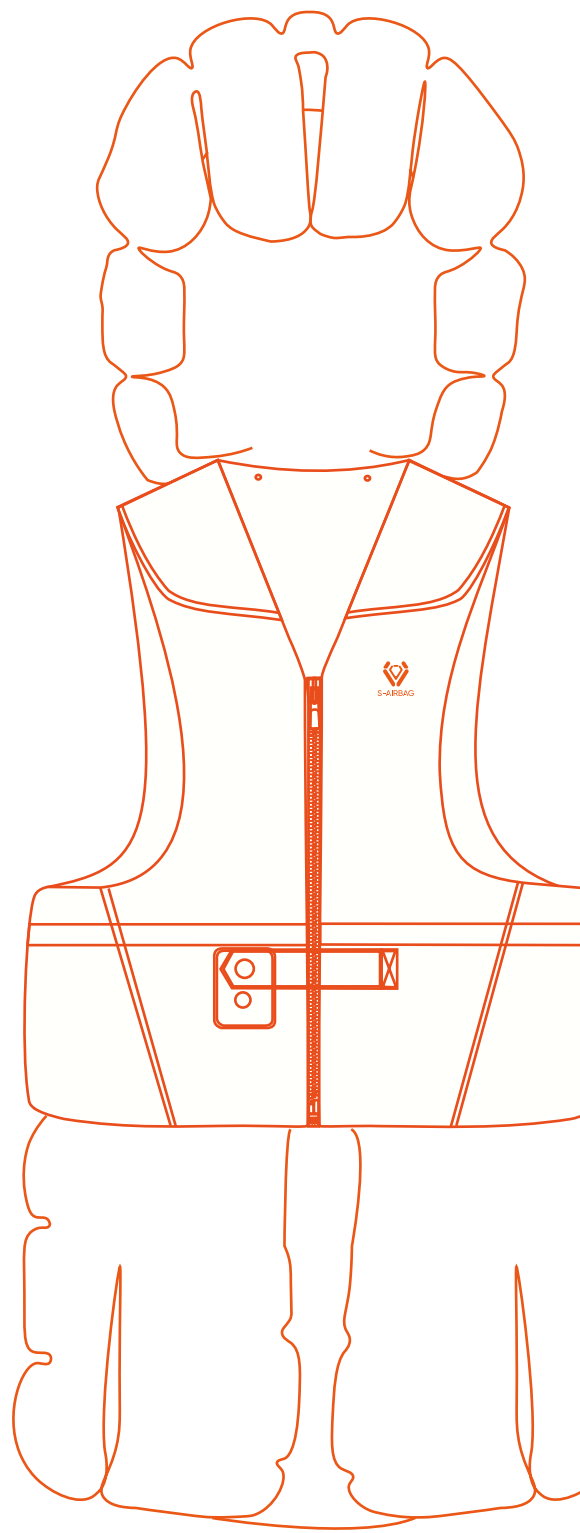

S-AIRBAG

General Information

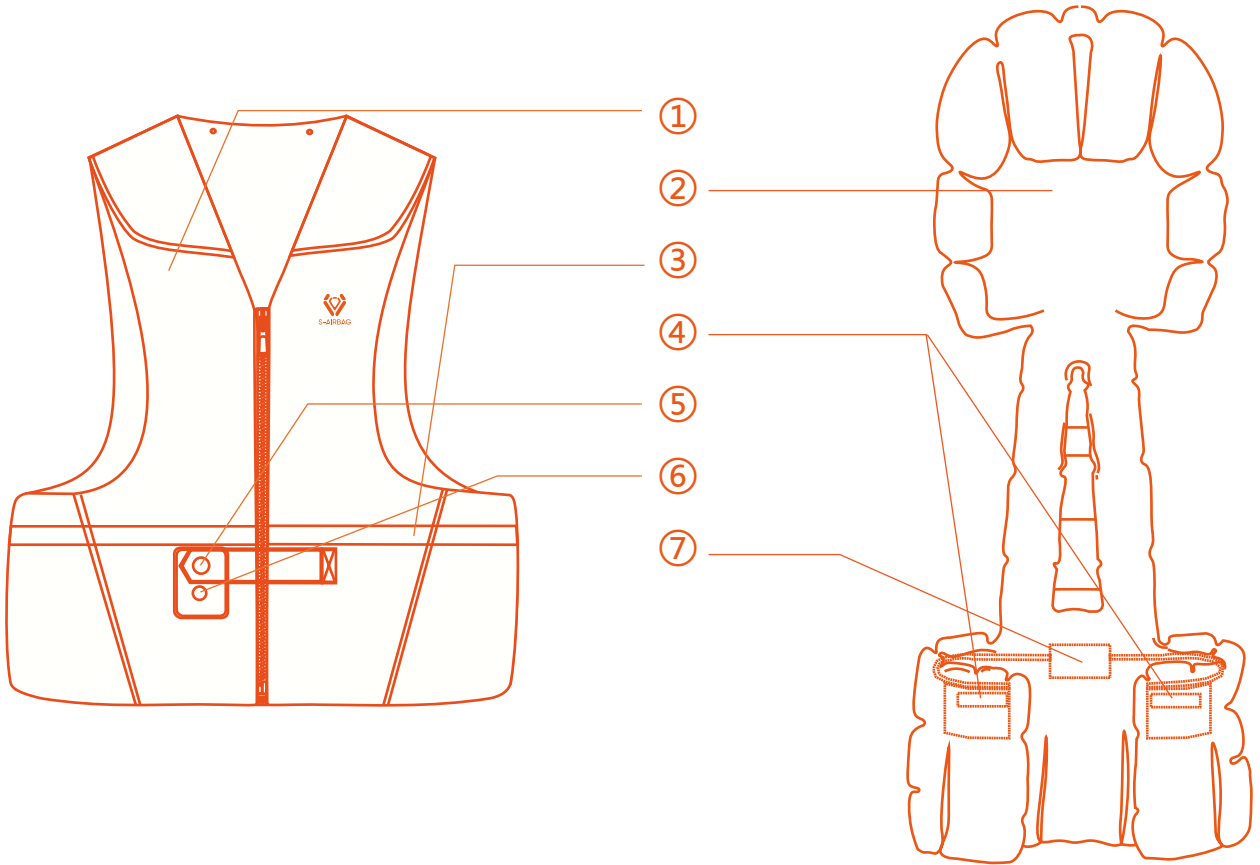

- ① Washable Wear-resisting Cover
- ② Auto Grade Airbag
- ③ Adjustment cord
- ④ Military Grade Inflator
- ⑤ Switch Button
- ⑥ Intelligent Indicator & Charging Port
- ⑦ High Precision Microchip Sensor

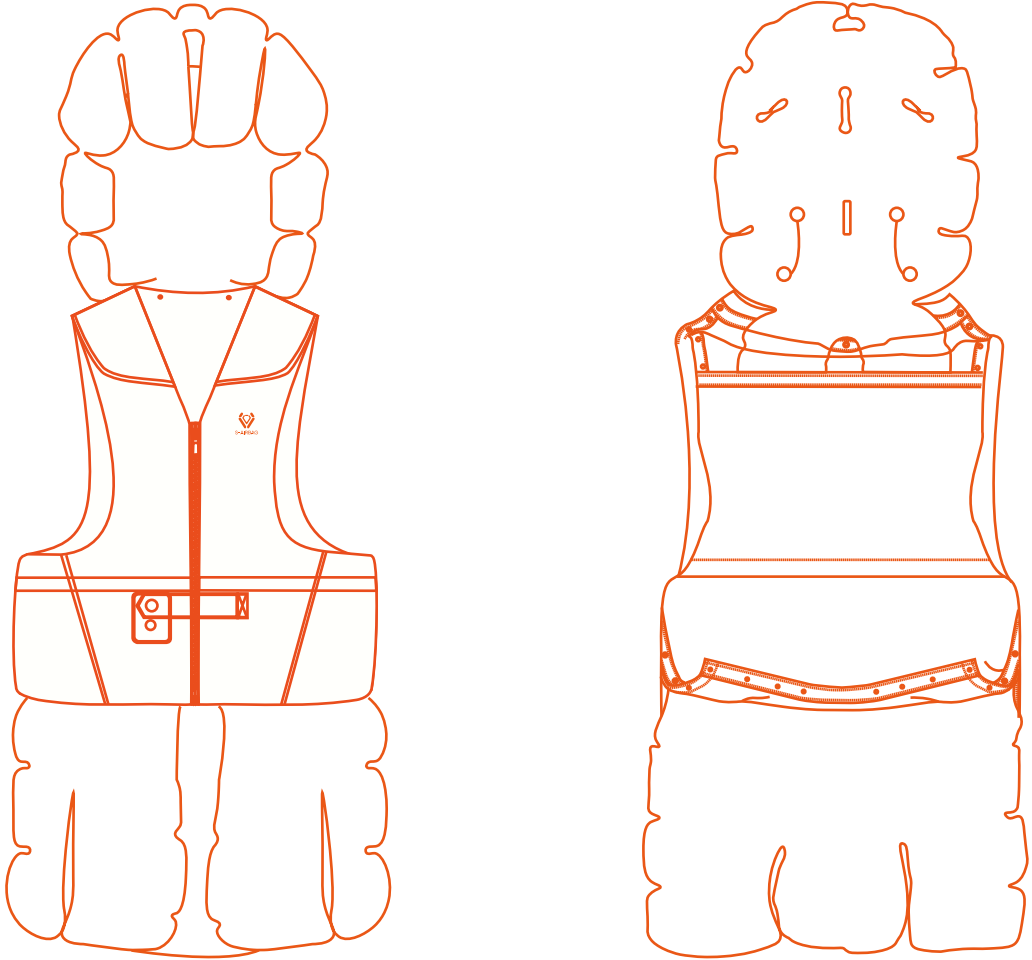

Product Name: S-AIRBAG INTELLIGENT VEST

Product Model: S30

Charging Current: 2A

Charging Voltage: 110-240V

Battery Capacity: 5000mAh

Technical Description

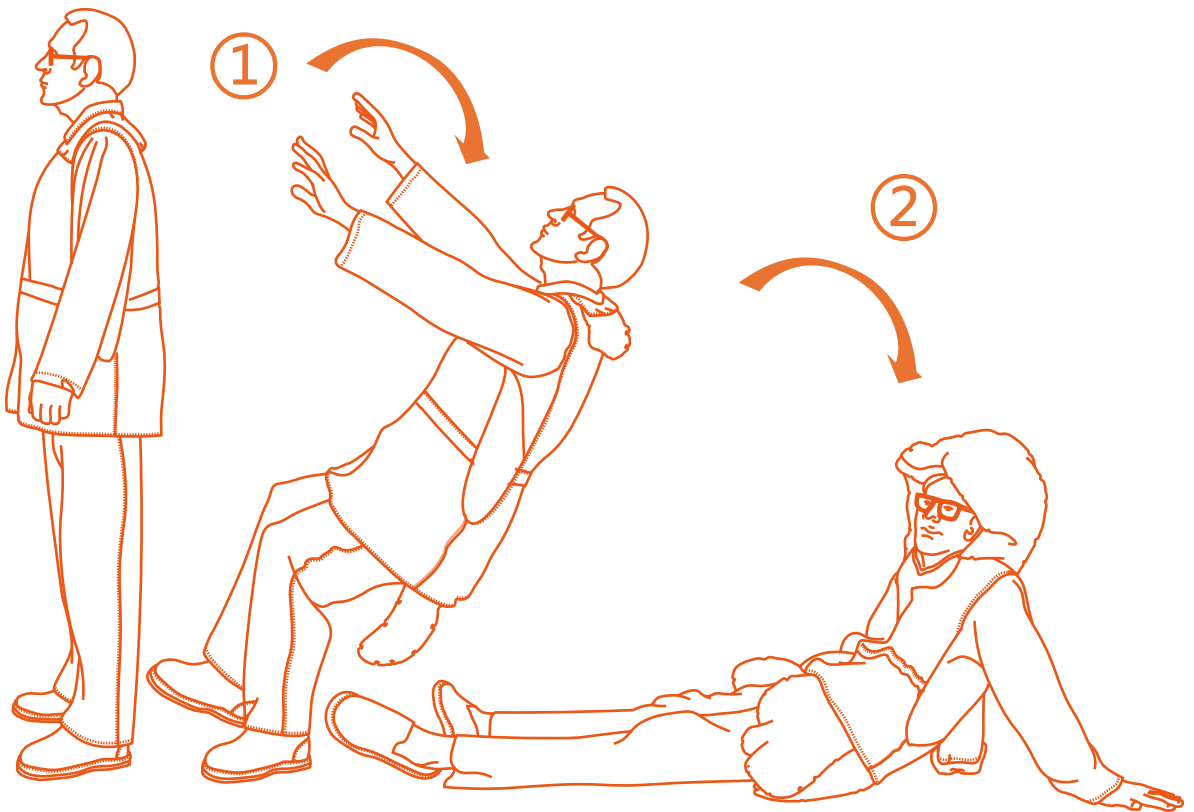

- ① The algorithm recognizes changes in human state
- ② The airbags deploy to protect the body

The sensor of the equipment collects human activity data, and tens of millions of human body tests form a core algorithm, which can judge whether the human body is weightless and issue instructions to transmit signals to the gas generator. The gas generator will rapidly inflate the gas in the compressed inflator into the airbag within 0.08 seconds, achieving a protective effect.

Packaging Details

The package contains: a S-AIRBAG Intelligent vest S30, a User Guide, a USB Power Adapter, and a USB Magnetic Charging Cable.

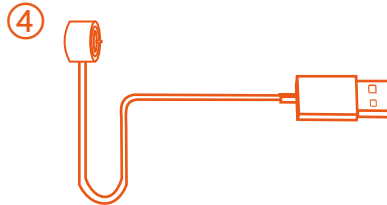

- ① S-AIRBAG Intelligent Vest S30: offer protection and reduce the risk of fall injury.
- ② User Guide: to better understand how to use the vest.
- ③ USB Power Adapter & ④ USB Magnetic Charging Cable: to recharge the battery of the vest.

Safety Precautions

Thank you for choosing S-AIRBAG to protect you in your daily life. Please read this user guide carefully in order to use the device properly. Failure to follow the instructions could lead to your device malfunctioning or reduce its effectiveness.

The S-AIRBAG INTELLIGENT VEST must fit your size. It must neither be too tight nor too loose. Use the following size chart for an indicative information about which size you should use:

SIZE	S	M	L	XL	2XL
Vest Length (cm)	61	63	65	67	69
Chest(cm)	106	116	126	136	146
Shoulder Width(cm)	42	43	44	45	46
Waist (cm)	106	116	126	136	146
Height (cm)	155-170	165-175	170-180	175-185	180-195

•Product manufacturing process affects the actual weight and size. If there is a difference, please refer to the actual product.

How to measure?

- ① Vest Length: measure the vest from the top to the bottom.
- ② Chest: measure horizontally around the fullest part of your chest under the armpits.
- ③ Shoulder Width: measure the maximum distance between the two shoulders.
- ④ Waist: measure horizontally around your abdominal.
- ⑤ Height: while standing upright, measure from your toe to the top of your head.

How to Wear S-AIRBAG Intelligent Vest

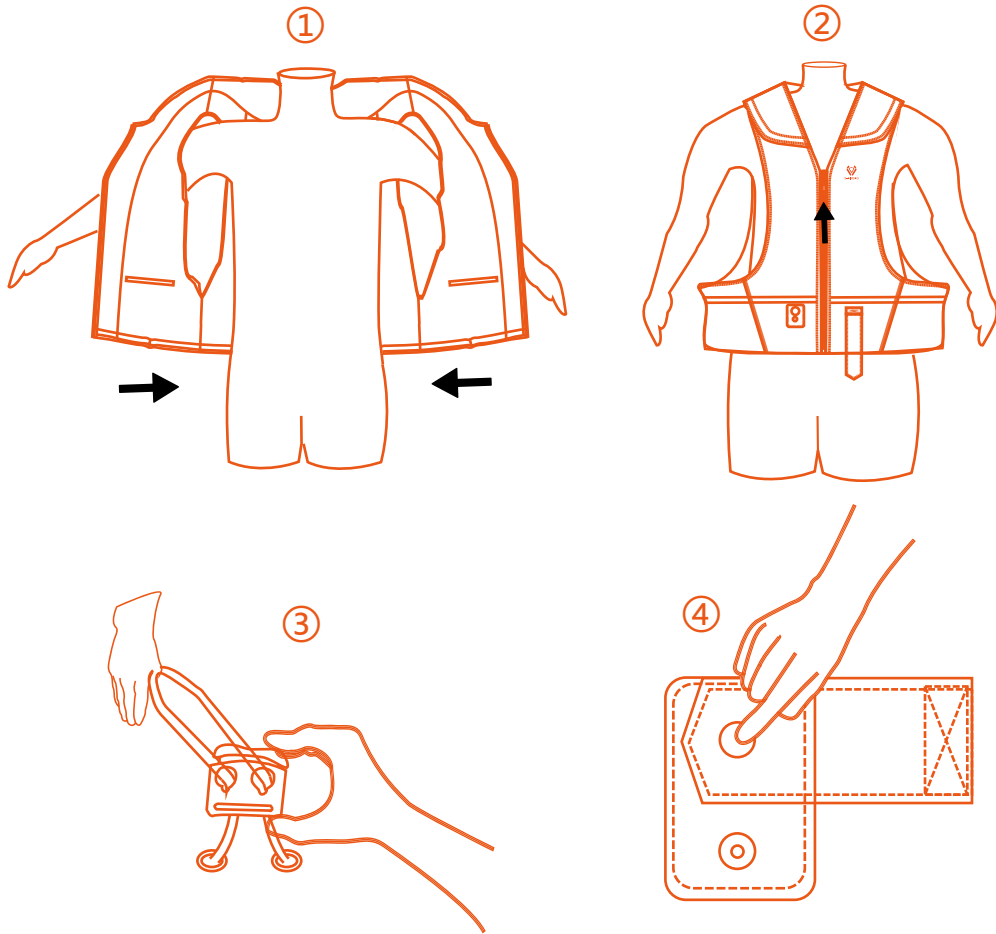

•Please make sure to adjust the clothes to fit comfortably with adjustment cord, otherwise it may affect the judgment of the sensor.

- ① Step1 : Put on the intelligent vest
- ② Step2: Zip up
- ③ Step3: Adjust the clothes to fit comfortably with adjustment cord.
- ④ Step4: Buckle the snap button to start working

How to Activate the Device

After putting on the vest, making sure that you have buckled the connecting snap button is crucial important. When you finish buckling the snap button, there will be an auto test with all lights on and with music which will continue for a short period(around 10 seconds), and when the music stops, that means you wear it properly, and the system is on.

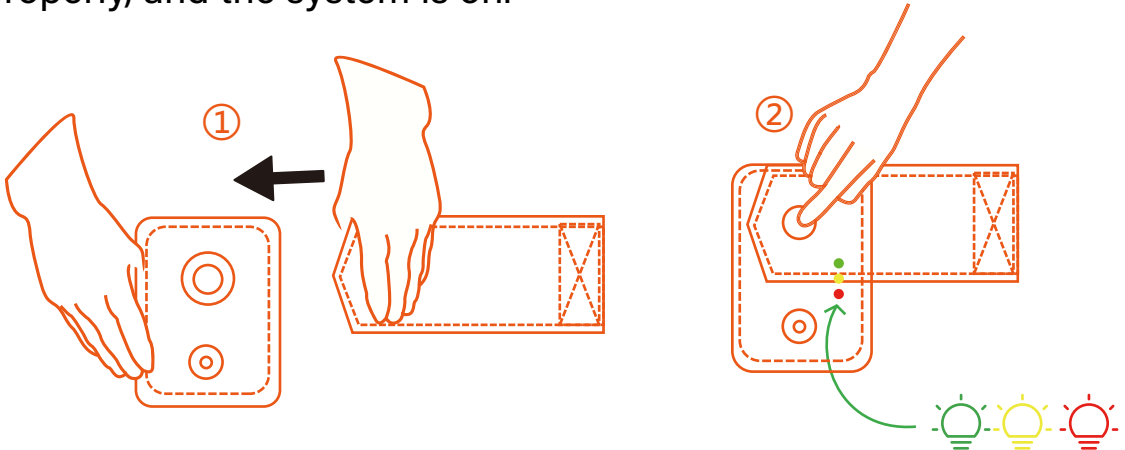

- ① Step1 : Snap button
- ② Step2 : Buckle the snap button



IMPORTANT

- If you cannot hear the auto test music, please unbuckle it and then buckle it again. If there is still no music, please contact the authorized dealer.
- Make sure you wear the vest outermost without any other clothes covering it.



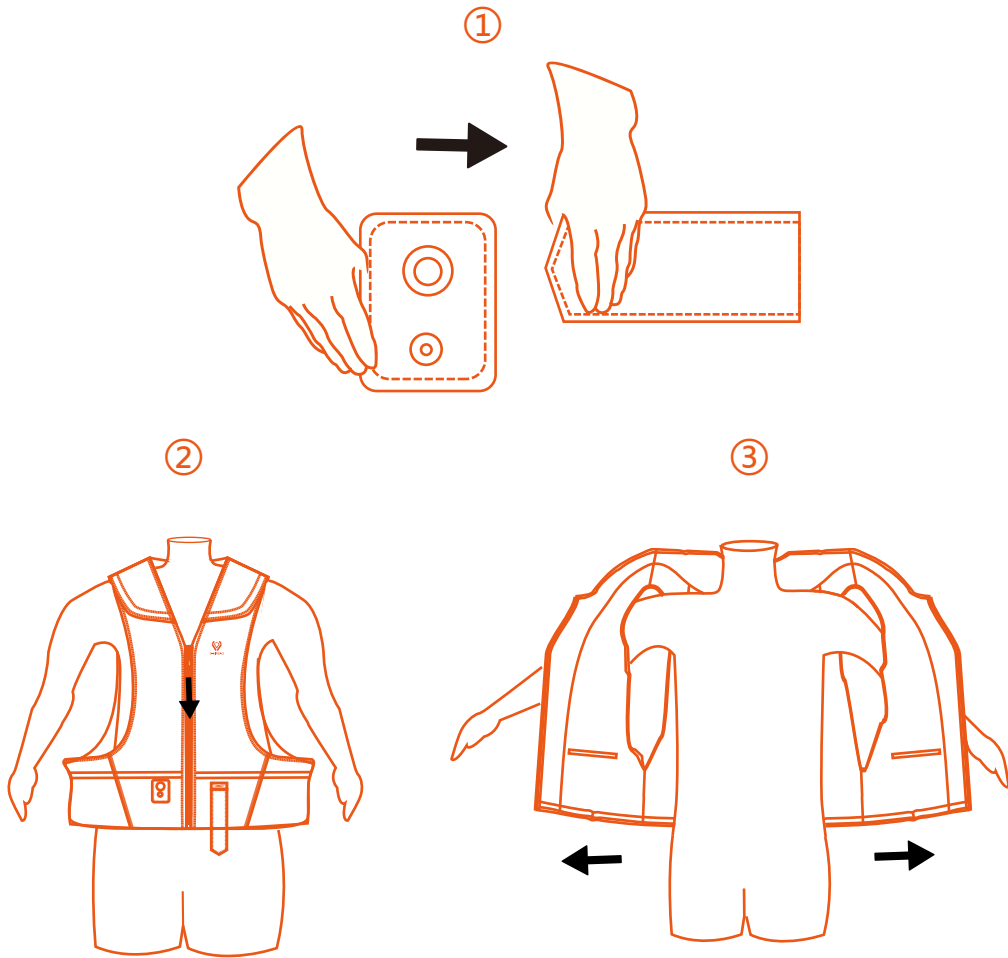



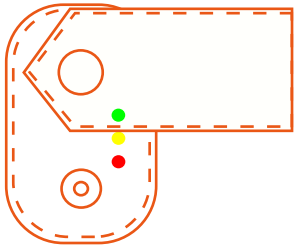

How to Deactivate the Device



- ① Step1 : Unbuckle the snap button
- ② Step2: Pull the zip down
- ③ Step3: Get off the intelligent vest

Light Signals & Charging the Battery



- a.  b.  c. 
  
  

① Battery Status:

- a. Solid GREEN light : battery more than 50%
b. Solid YELLOW light: battery between 10%-50%
c. Flashing RED light: battery less than 10% (with audio rapid beep tone, means the device needs to be charged immediately)

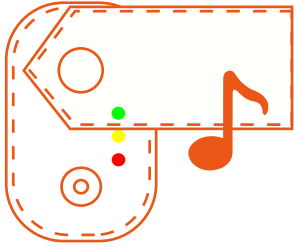

d.



② Malfunction Notice:

- d. RED, GREEN and YELLOW lights all flashing with audio slow beep tone, means the device needs to be rechecked before use.

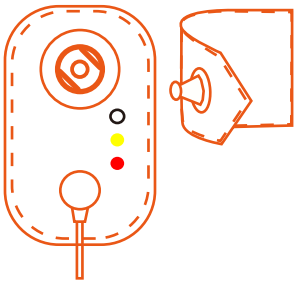

e. f.

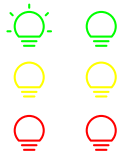

③ Charging Battery:

- e. Flashing RED or GREEN or YELLOW light means the device is charging (make sure not to buckle the snap button while charging the battery)
f. Solid RED, YELLOW and GREEN lights means the device is fully charged

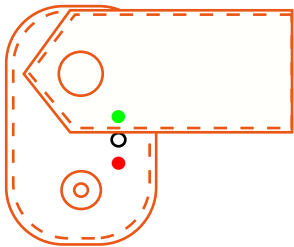

g.



④ Sleep mode:

- g. When the user lies down or lays the vest flat, the system will be in SLEEP MODE with solid RED and GREEN lights on the same time.



IMPORTANT

- Make sure not to buckle the snap button while charging the battery.
- Each time when you put on the vest and buckle the snap button, the system will start detecting process with RED, GREEN, and YELLOW lights all on. When the detecting process is finished, the system will work automatically with the battery status light on.
- Pay attention to the battery status and make sure the device has enough power.
- When there is malfunction notice with all the lights flashing, please check the inflators or contact the authorized dealer.

How users connect to the S-AIRBAG APP

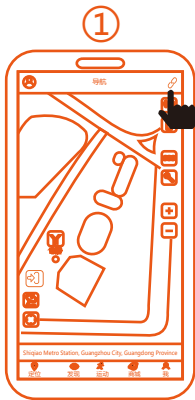

Open S-AIRBAG APP,
click "connect device"

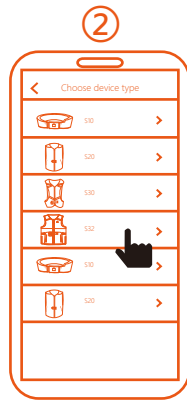

Select your device



click "wearer"

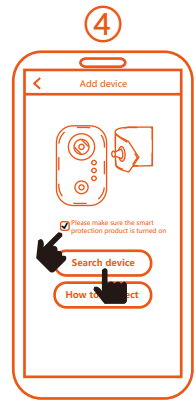

1.How to connect
2.Click "Search device"

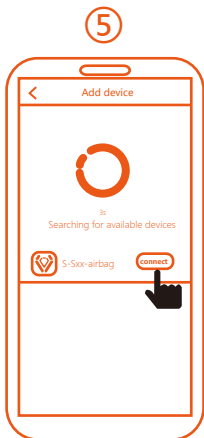

choose S-Sxx-airbag,-
click "connect"

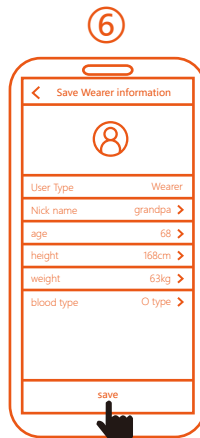

1.fill in Wearer information
2.Click "save"

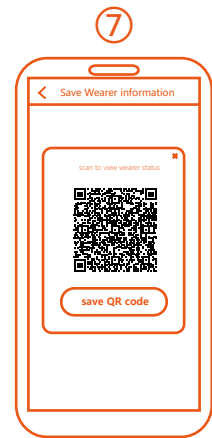

Finish connecting
S-AIRBAG APP



IMPORTANT

- Please make sure you are dressed and buckled up;
- Please make sure your phone has Bluetooth on and your phone is connected to the Internet;
- Please make sure the phone is within 5 meters of the S-AIRBAG product;
- The device has not been searched after buckling, please make sure whether other phones have become the role of the wearer, the wearer can only have one phone;
- Please note that bluetooth devices need to be bound to the wearer first, and other guardians should scan the QR code generated after the wearer is bound successfully (if not saved, please open app-My-MyDevice-click saved device-click the code in the upper right corner to display the QR code).

How guardian connect to the S-AIRBAG APP

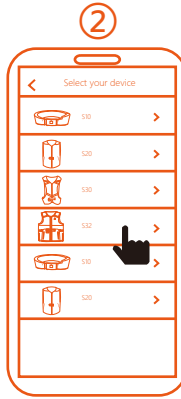
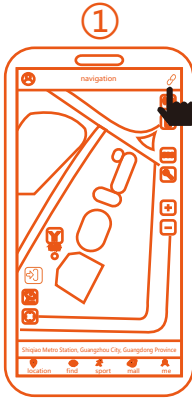

How guardian connect to the S-AIRBAG APP

Select your device

click "guardian"

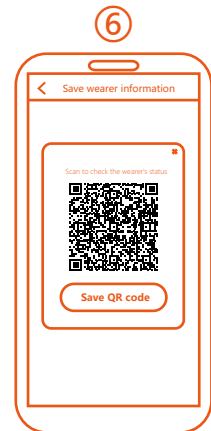
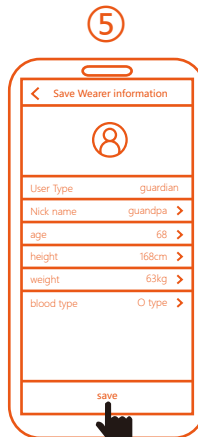

scan the QR code of the wearer

1.fill in Wearer information
2.Click "save"

Finish connecting S-AIRBAG APP



IMPORTANT

•Please make sure the user is connected to the S-AIRBAG APP.

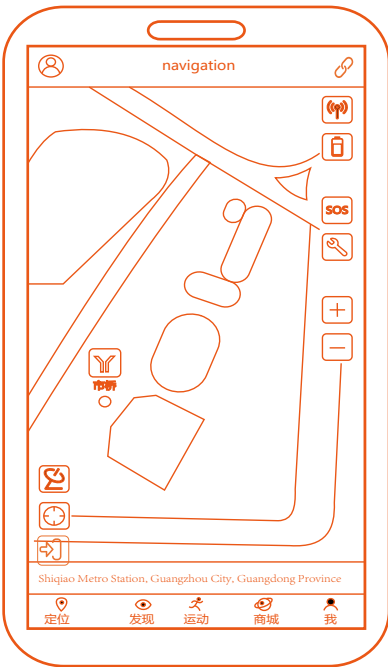

Device Startup

Display the device startup status



Satellite Positioning

Real-time satellite positioning



Location Positioning

Positioning to the current device location



Device Signal

Display the device signal condition



Device Power

Display the device battery status



SOS Alarm

After the device triggers an alarm, the associated APP will receive the device alarm, including alarm location. Associated family members can contact immediately or take rescue measures (this feature requires permission that this program keeps running in the backend of the phone)



Malfunction Alarm

When there is a malfunction of the device, the mark will be displayed in red, and a fault message will pop up on the display screen. When the screen is off, you can press the malfunction button to re-show the fault message again.

Internet Function

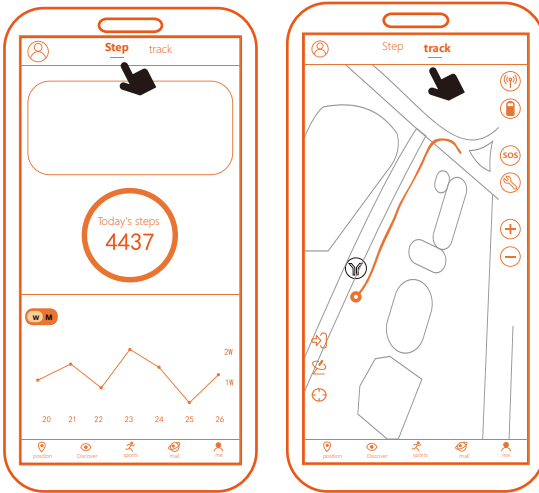

Steps & Tracks

- ① Click [Sports] to view the step record of the day;
- ② Click [week/month] to switch the duration, you can view 7days' track record;
- ③ Click [Sports]-[Track] to view the track record.

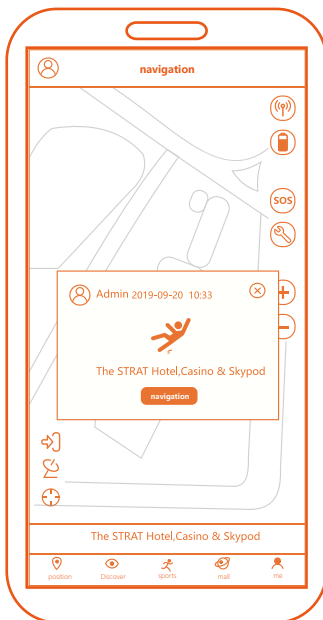

SOS Alarm

When the wearer falls down, the airbag will be triggered to protect the user. The SOS alarm with buzzer beep will appear on the screen and the associated APP will pop up an alarm notice page simultaneously. In the meantime, the fall location and the optimal navigation route will be shown to the caregiver for immediate rescue.

After Inflation

The inflators inside are to trigger the airbags in case of fall and for single use only. After the device's airbag is deployed, the inflators must be replaced and the airbags need to be folded after each fall.

You could replace the consumables by yourself by referring to the following steps or by referring to the TUTORIAL VIDEO on our website:

<https://www.s-airbag.com>

You can also contact your authorized dealer for support if needed. Please do make sure you replace the inflators and fold the airbag correctly.

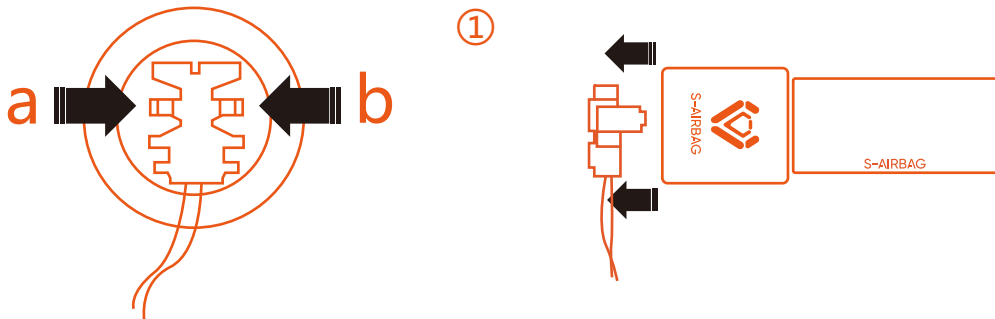

Step1 : Press both ends of a and b and pull out the terminal cable simultaneously.



Step2 : Screw out the two inflators anticlockwise.



IMPORTANT

- Please make sure you use the same type of gas inflators when you replace them after inflation.

After Inflation

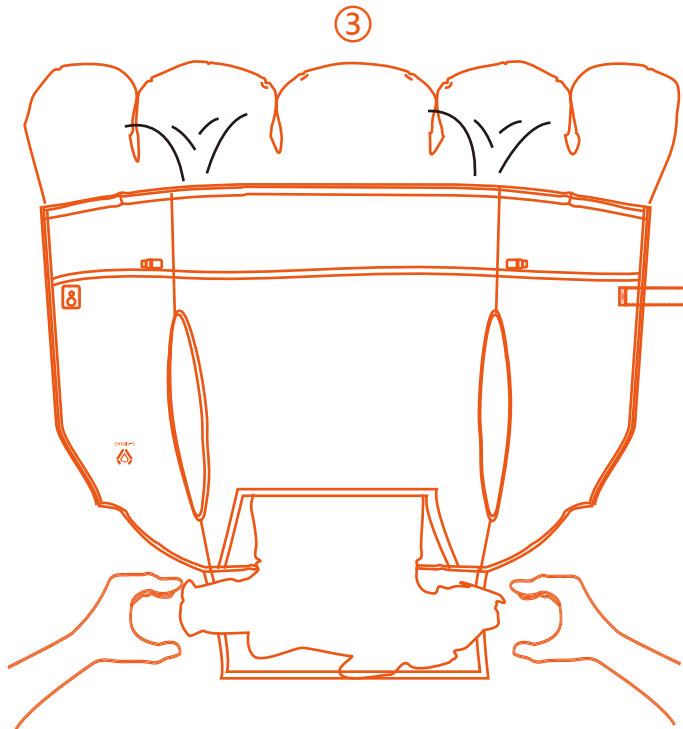

Step3 : Flatten the vest with the inner side down, and the outer side (the logo side) up, squeeze the gas out from the head area airbag to the hip area airbag.

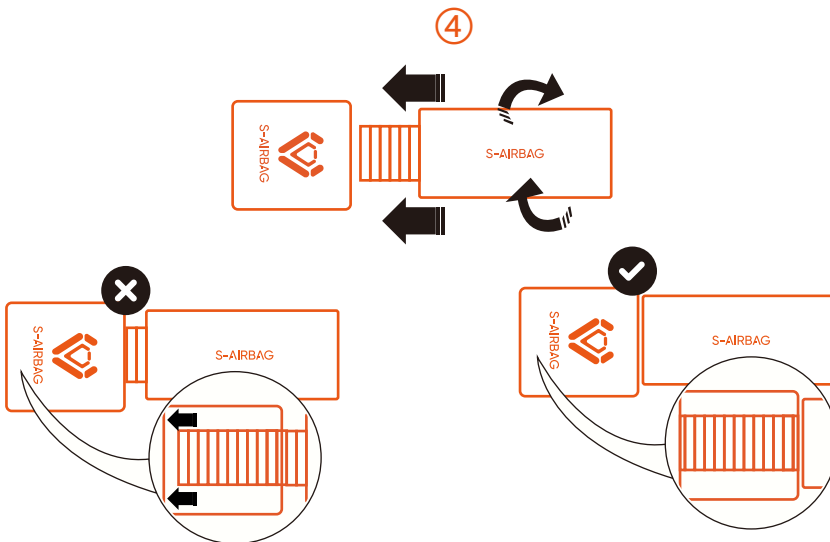

Step4 : Replace new inflators by screwing in clockwise.

- Make sure that you completely screw in the inflators.

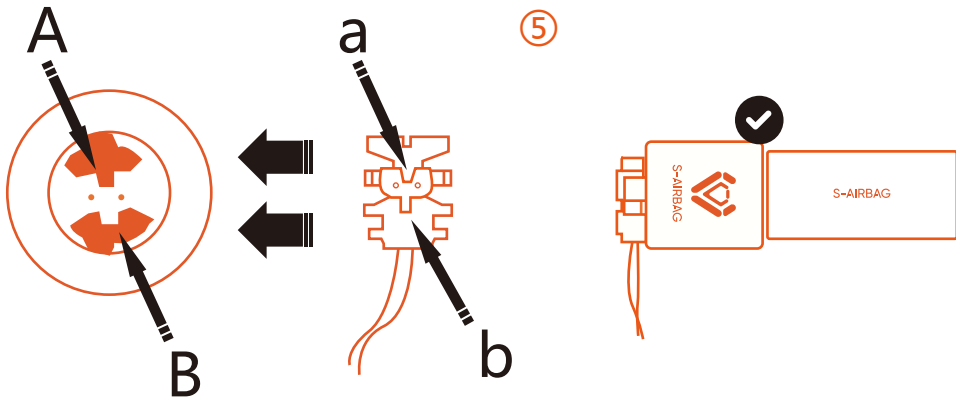

Step5 :Match A to a, B to b, and plug in the terminal cable.

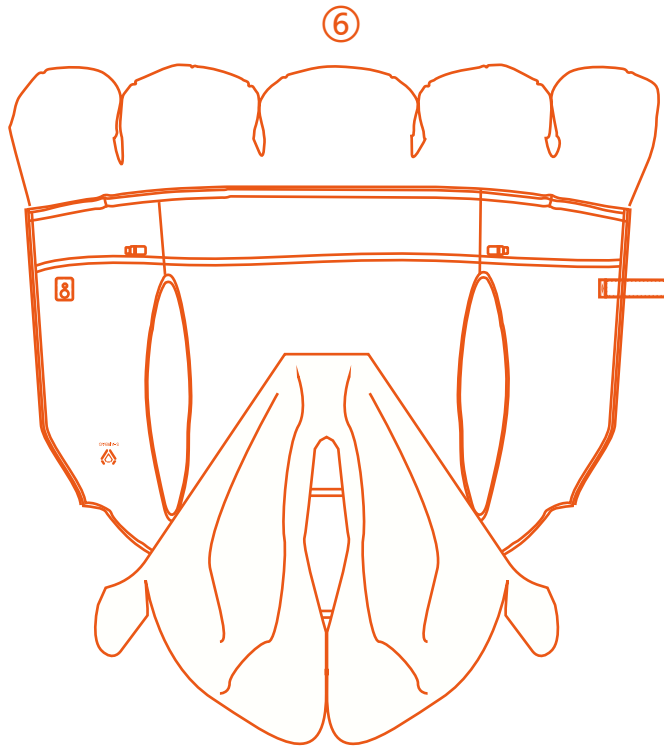

Step6 :Flatten the vest with the inner side down, and the outer side (the logo side) up, flatten the head area airbag.

After Inflation

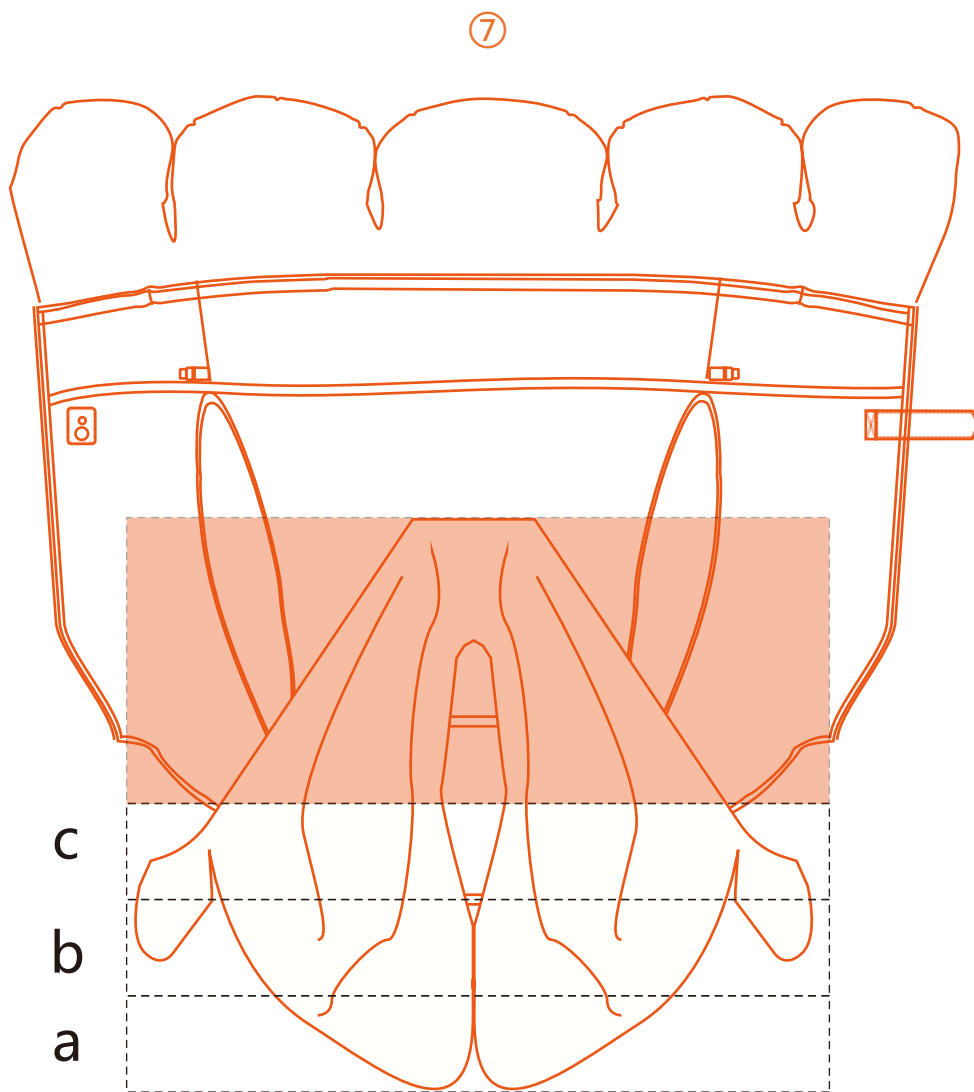

Step7 :Divide the head area airbag into two parts,the bottom half part again divide into three smaller parts.

8

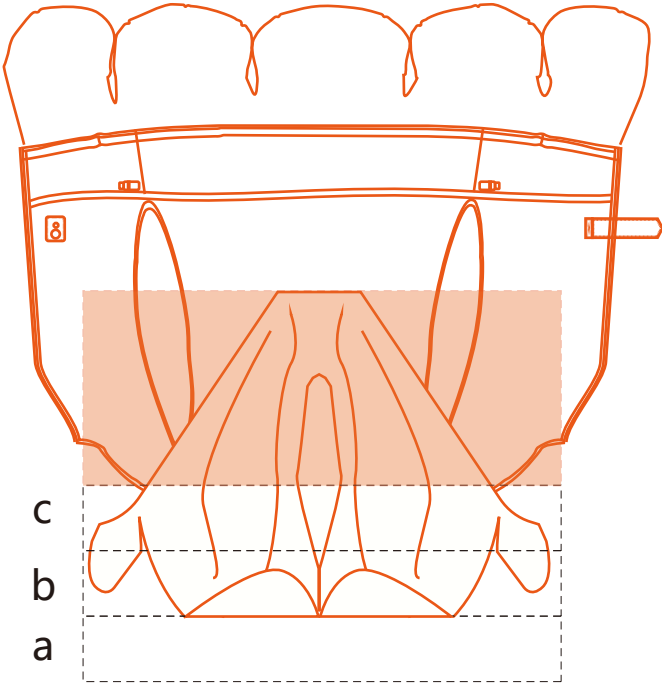
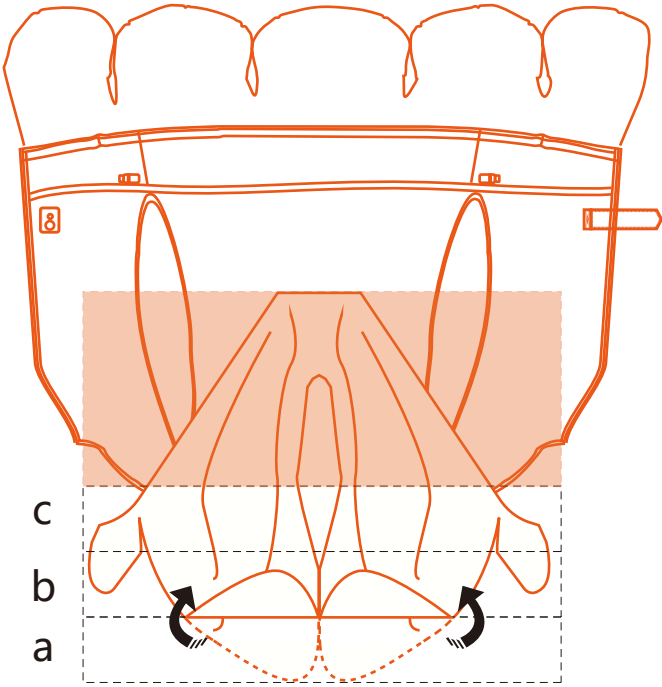

After Inflation

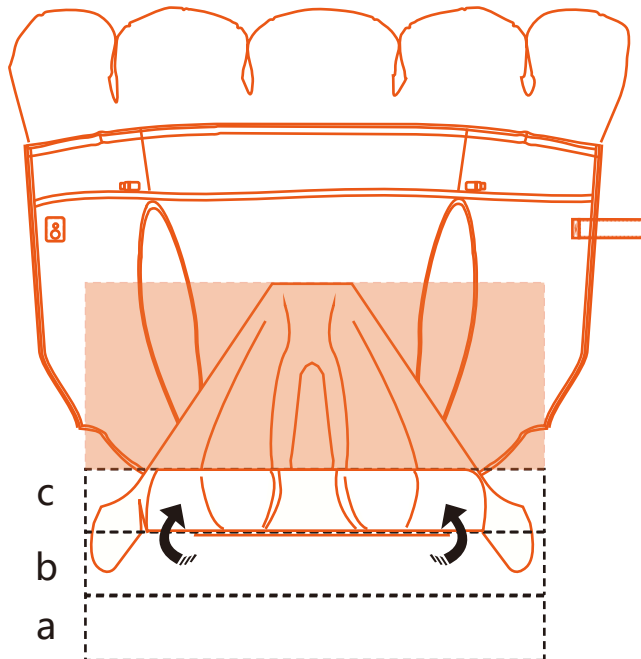
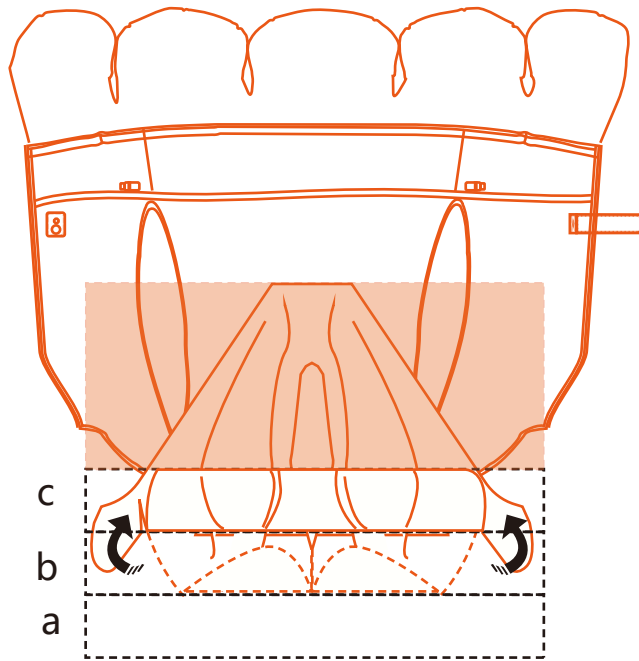

Step8 :First fold the bottom part of the head area airbag, from A to B ,then from B to C.

9

After Inflation

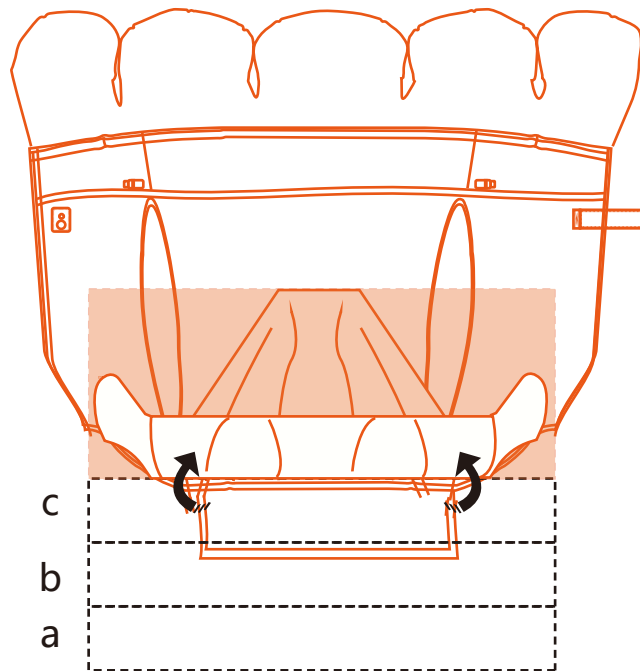
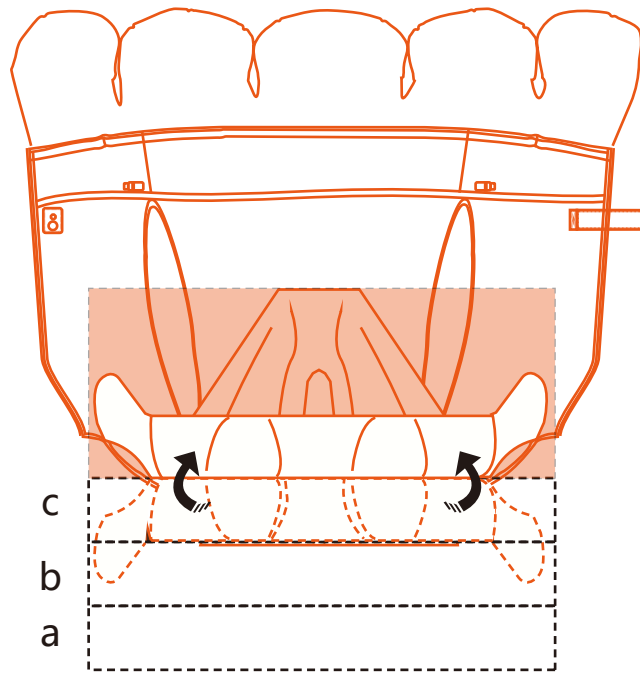

Step9 :Fold c to the upper half part of the head area airbag.

After Inflation

10

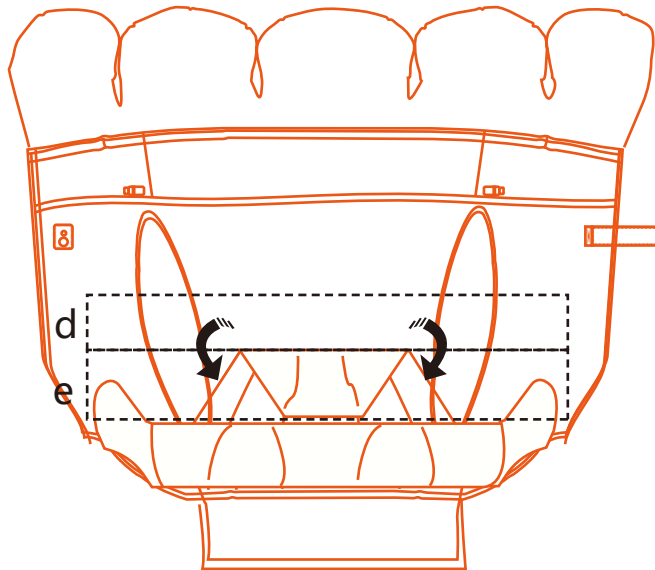
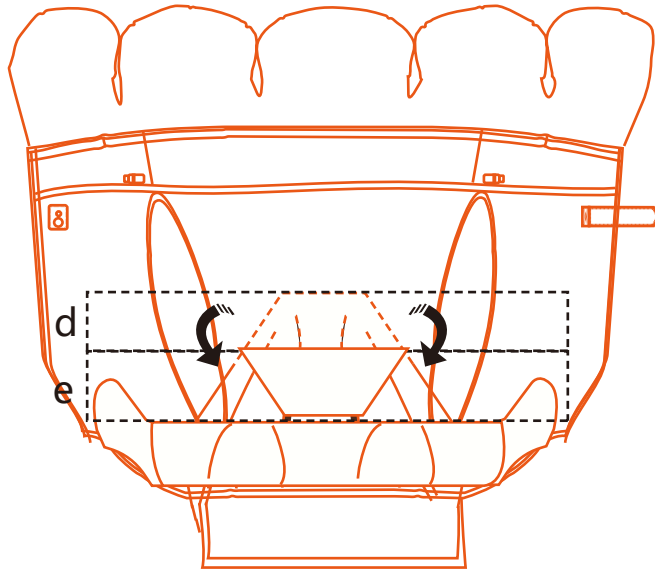

Step10 :Fold the upper part of the head area airbag from d to e.

11

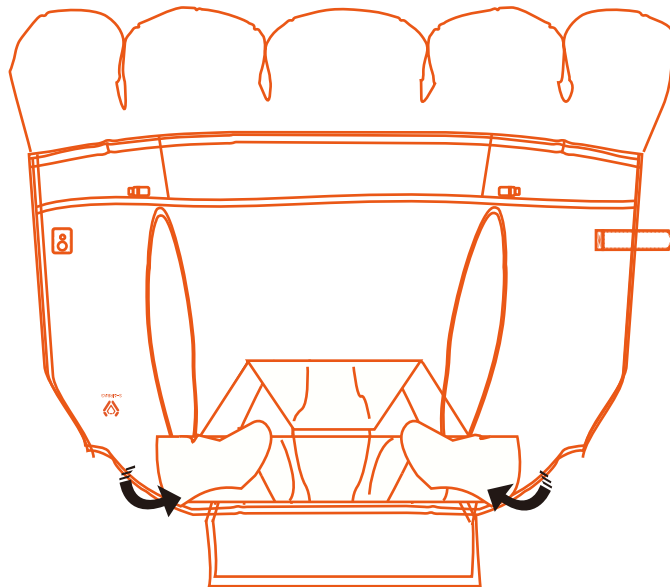
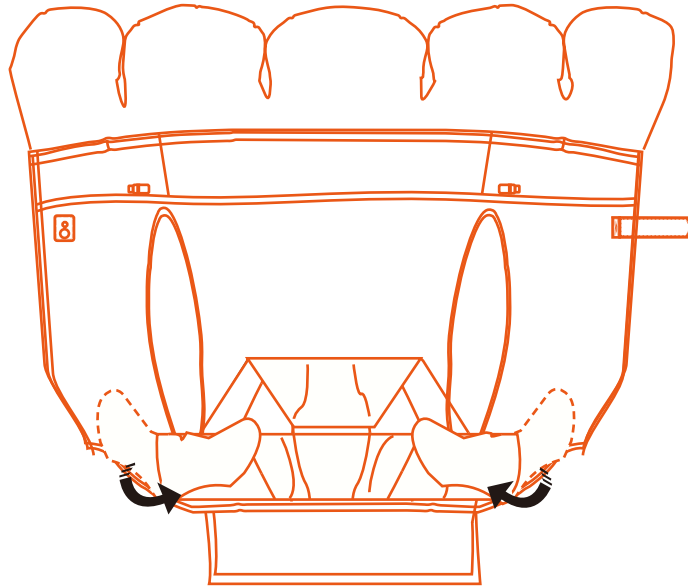

Step11 :Fold the extra airbag of head area on each side.

After Inflation

12

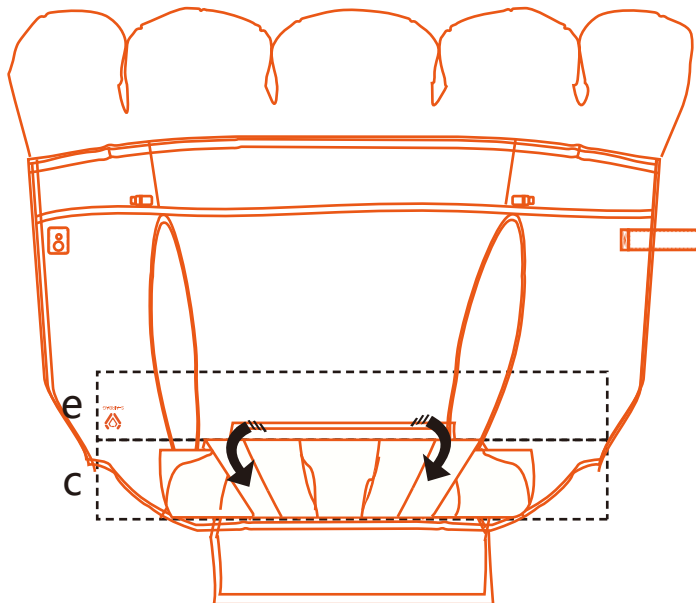
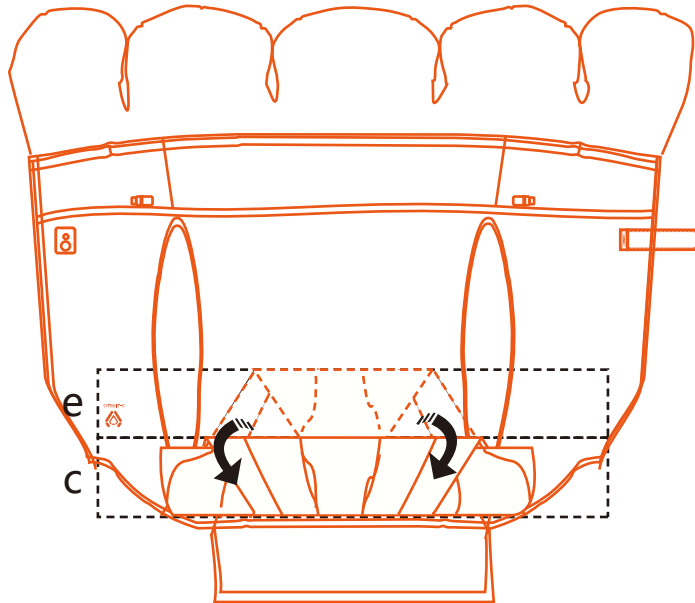

Step12 :Fold the whole e and cover the c.

13

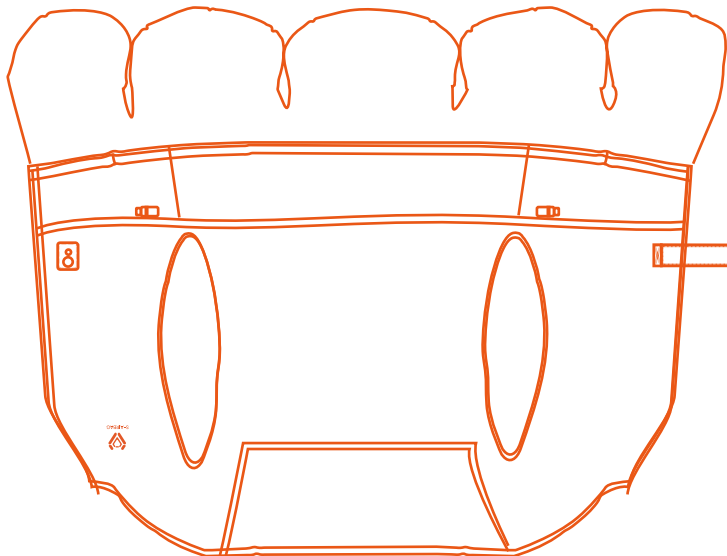
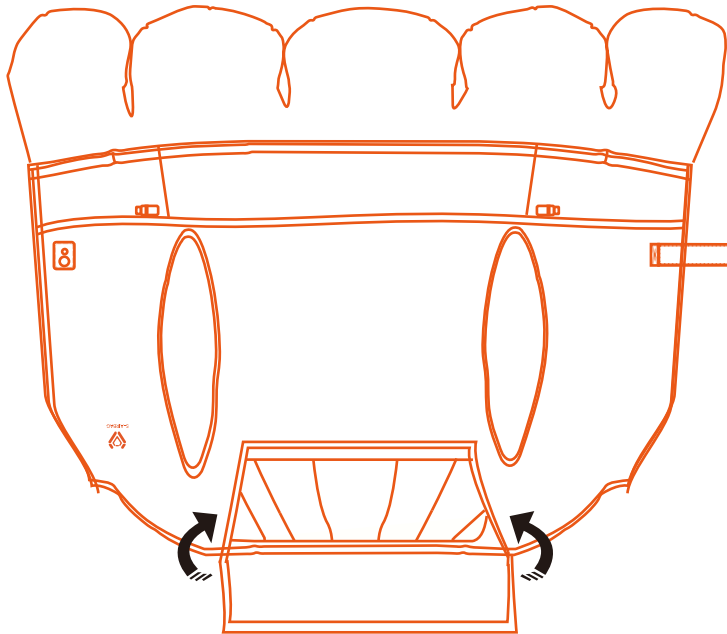

Step13 :Put the folded head area airbag into the vest, and buckle the snap buttons accordingly.

14

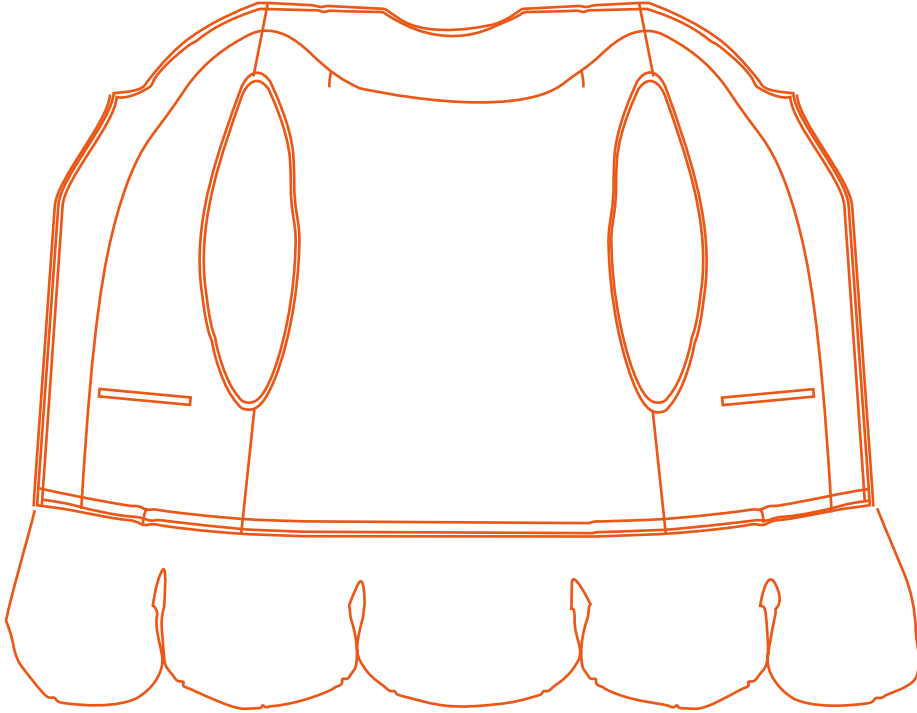

Step14 :After folding the head area airbag, turn the inner side of the vest up and the outer side (the logo side) down. Flatten the vest and the hip area airbag.

15

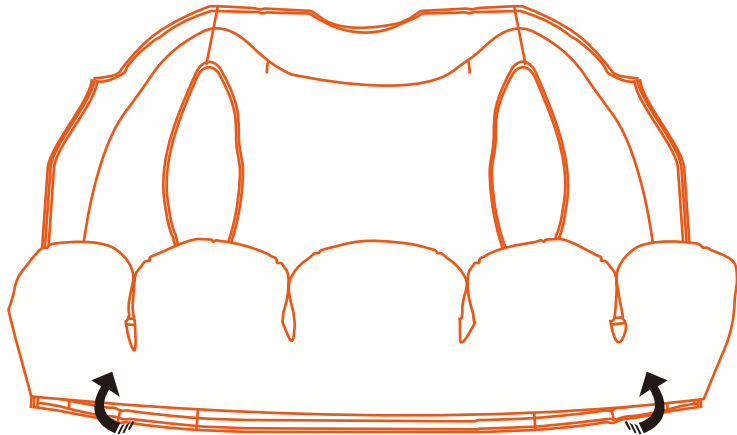
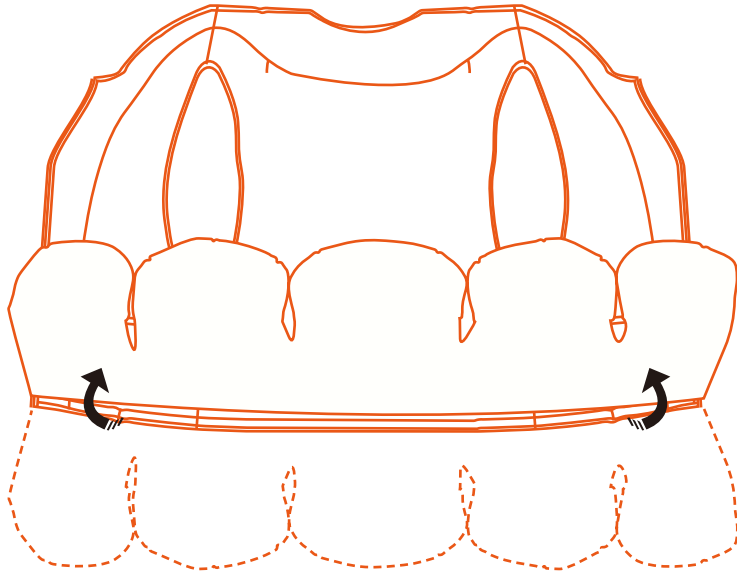

Step15 :Fold the hip area airbag up until the bottom aligning with the bottom of the vest.

16

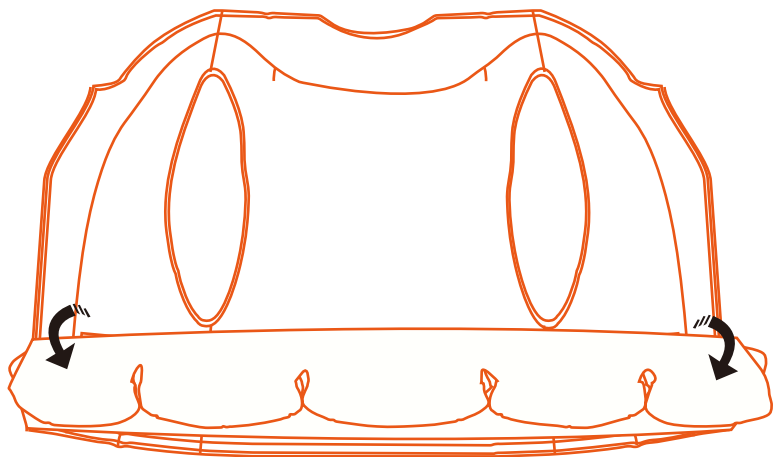
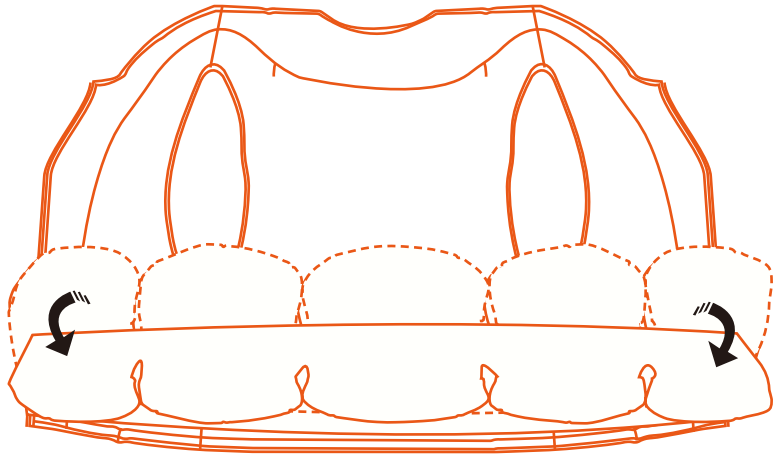

Step16 :Again fold the hip area airbag until it reaches the bottom of the vest.

17

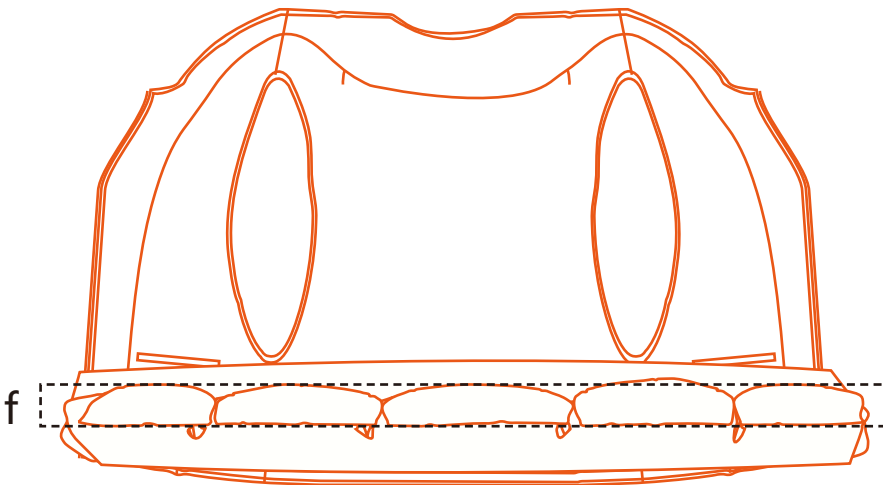
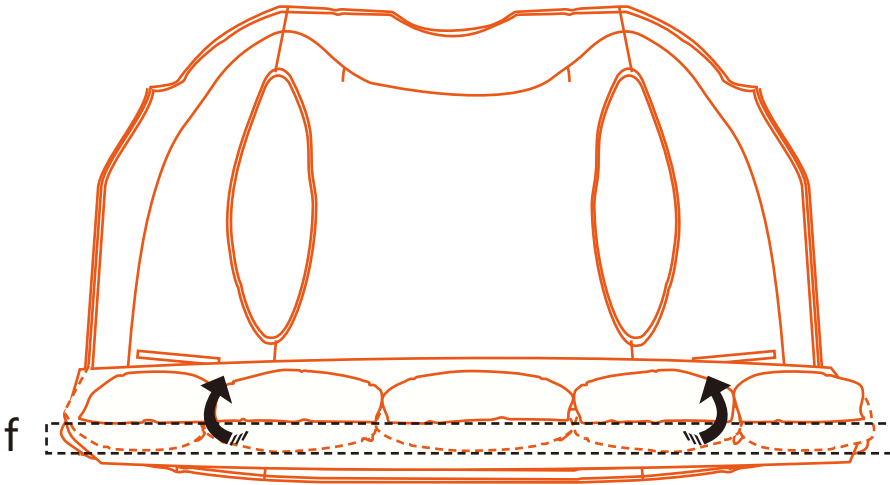

Step17 :Fold the smaller part of the hip area airbag up (showed as f).

18

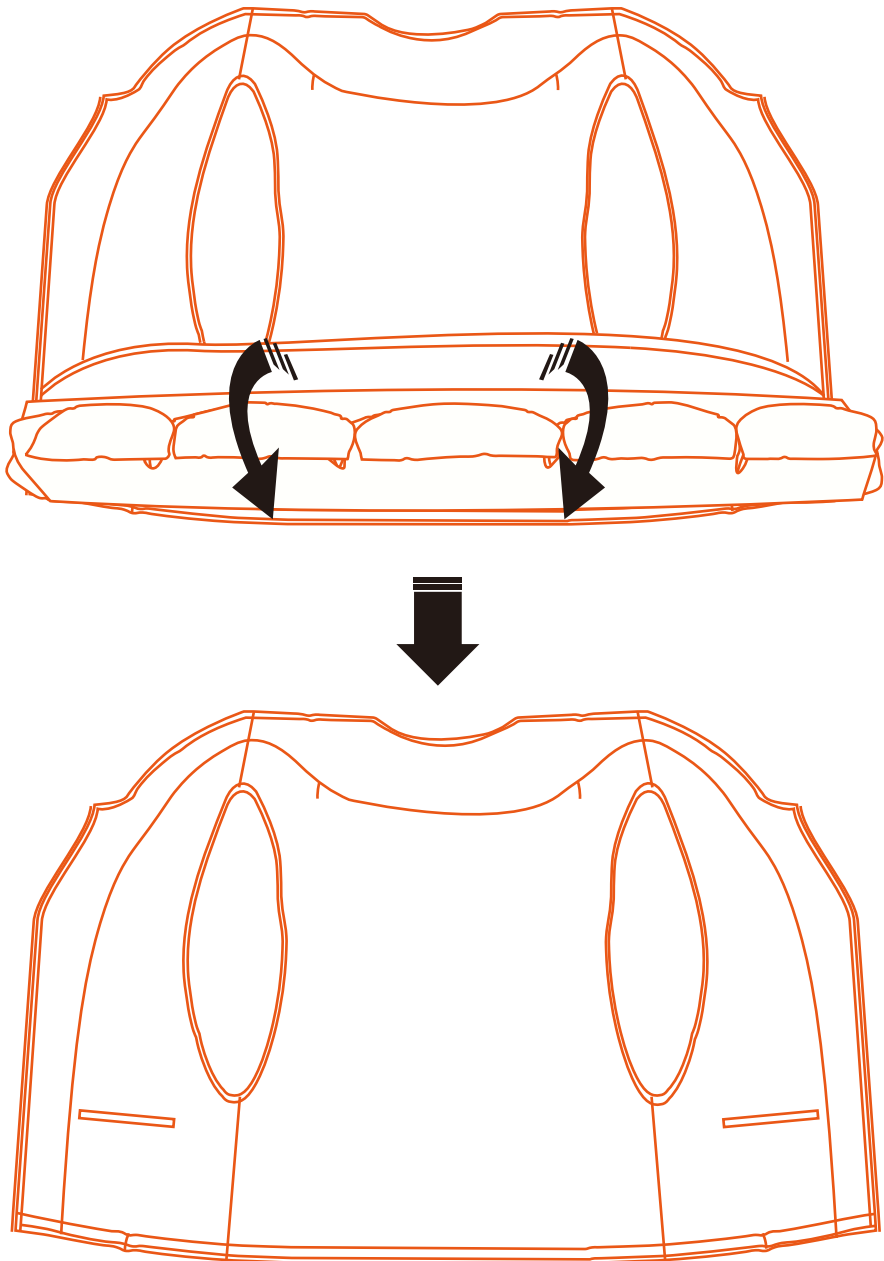

Step18 :Put the folded hip area airbag into the vest, and buckle the snap buttons accordingly.

▶ Caution before Using the Product

① Check your S-AIRBAG INTELLIGENT VEST is in good condition, i.e. no rips or tears, before each use. If some damage occurs, please contact the authorized dealer or our customer service team for further information.

▶ Caution after Airbag Deployment

① Once the airbag is deployed, the inflator must be replaced with a new one of the same capacity. Please be noted each vest contains two inflators. Contact the authorized dealer or our customer service team for support.

▶ Caution of Storage

① Do not remove or disassemble any part of the internal structure of the device by yourself.

② This device contains delicate parts and should be handled carefully. Keep out of reach of children.

③ Please use our original power adapter only and keep the device away from fire or other heat sources and sharp objects.

④ Please fully charge the battery when it is not used for a long time.

⑤ Keep the snap button unbuckle when the device is not in use.

⑥ If not used for a long time, please remove the battery.

⑦ Except for the cover of the Intelligent vest, other parts cannot be washed because it contains battery inside. Please keep it separately with other items.

▶ Others

① Do not wear the device when you are bathing or sleeping.

② To avoid accidental triggering when taking a vehicle, please unbuckle the snap button or take off the device.

③ Do not sew/iron or stick anything on the S-AIRBAG INTELLIGENT VEST as it could pierce the airbag and prevent them from working properly.

Disclaimer

Please make sure that you wear our products properly as per the instructions of our user guide, otherwise the S-AIRBAG intelligent vest could not inflate properly.

- ① Please make sure that you wear our products properly as per the instructions of our user guide.
- ② Please note that no device can prevent death or serious injury in certain accidents. This device could only absorb shocks and offer certain support for the head, back, hip and pelvis, thus reducing the risk of fall injury.
- ③ The triggering protection of the airbag is based on the fall of the wearer in a normal standing posture or walking state. But for other situations, such as holding the handrail to fall slowly when falling down or falling in a sitting or squatting position, the device may not deploy the airbag to protect because of its slow falling speed. The vest only deploys the airbag in cases of serious impacting falls. Though these types of falls are devastating, they only account for a small percentage of all falls.
- ④ For severe osteoporosis patients, fractures may occur even with a slight collision. Therefore, it is recommended to seek medical treatment to avoid the risk of injury.
- ⑤ It is recommended not to wear any garment or backpack over the S-AIRBAG INTELLIGENT VEST.
- ⑥ The S-AIRBAG INTELLIGENT VEST protects only when inflated.
- ⑦ Please take proper protective measures during non-product wearing periods (including but not limited to anti-slip in the bathroom and protection of get up at night).
- ⑧ When you are taking the transportation tools, the device cannot provide you effective protection.
- ⑨ When you are engaged in intense sports such as running and dancing, please do not use this product because the built-in sensor of the product may detect that you are about to fall and deploy the airbag to protect. In addition, it is not recommended for people with implantable electronic medical devices such as cardiac pacemakers.
- ⑩ S-AIRBAG will be held in no way responsible for any bodily injury or death, and/or property damage that may occur whilst using any S-AIRBAG products improperly. Our device could only reduce the risk of fall injury, but could not prevent death or serious injury during certain accidents.

For more information,
please visit www.s-airbag.com or
send email to info@s-airbag.com